

S440R/G A

ZEESTER
ÉTOILE DE MER
OCEAN STAR
SEESTERN
ESTRELLA DE MAR
STELLA MARINA

Montagehandleiding Notice de montage Assembling manual Montageanleitung Instrucciones para el montaje Istruzioni di installazione

Leeftijd
Age group
Age / Alter
Edad / Età
3 - 12

EUROPLAY nv
Eegene 9
B-9200 DENDERMONDE
tel. 32.52.22 66 22
fax.32.52.22 67 22
www.europlay.eu

Dat.: 18/11/2020

Rev.: -

Page: 1/7

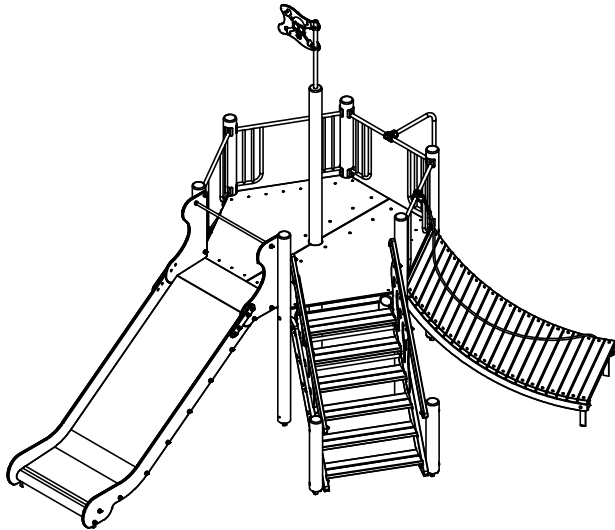

535kg

VALHOOGTE / HAUTEUR DE CHUTE /
FALL HEIGHT / FALLHÖHE/
ALTURA DE CAÍDA / ALTEZZA DI CADUTA

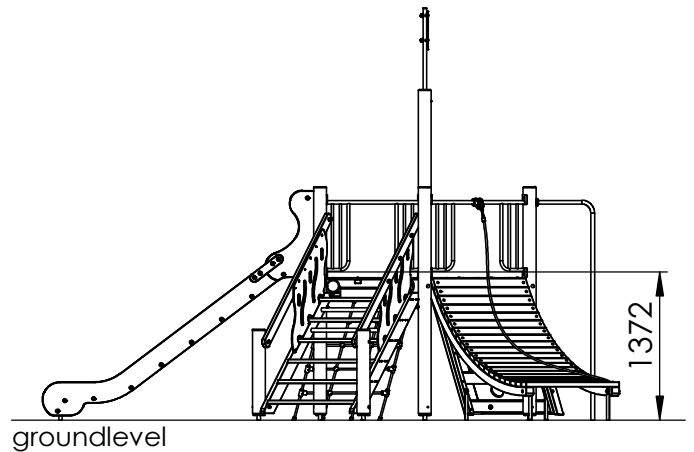

VEILIGHEIDSAFSTAND / ESPACE DE CHUTE / SAFETY AREA /
SICHERHEITSAFSTAND / ZONA DE SEGURIDAD / DISTANZA DI SICUREZZA

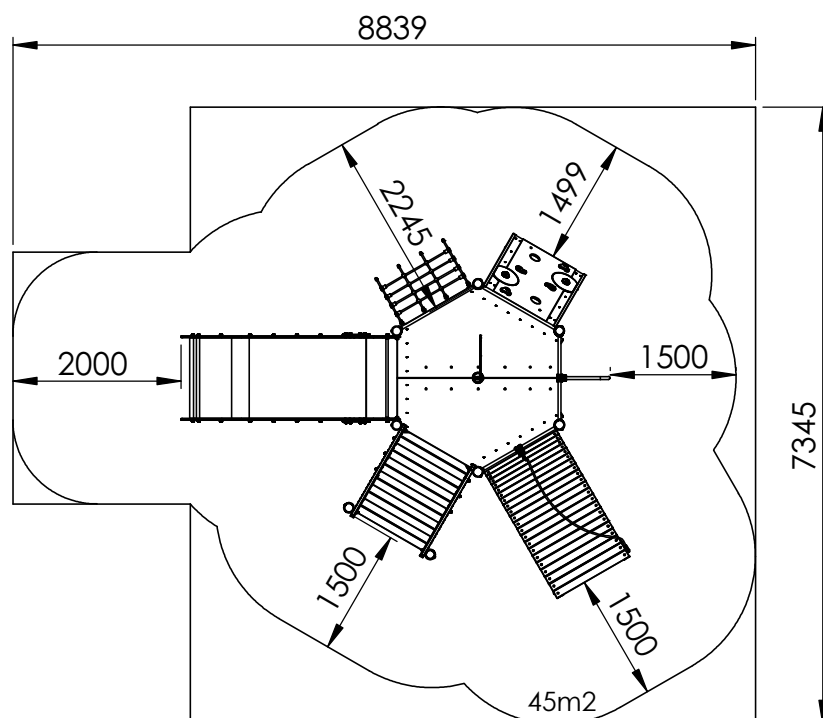

AFMETINGEN
DIMENSIONS
MASSE
DIMENSIONES
DIMENSIONI
L: 5,4m
Br: 4,4m
H: 3,9m

56m²

Benodigdheden - Liste des pièces - Materials - Benötigtes - Accesorios - Requisiti

1x **S440A** BASIC

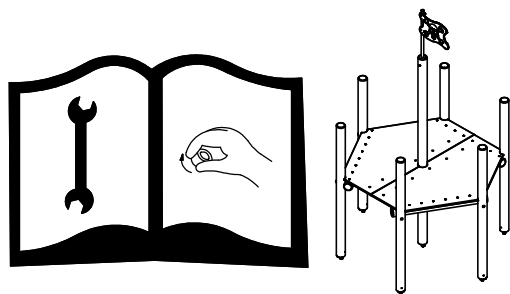

1x **G112R/G A**

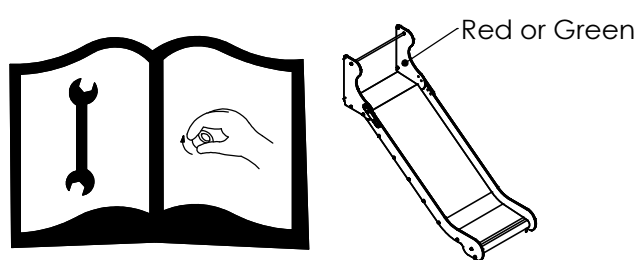

1x **L710A**

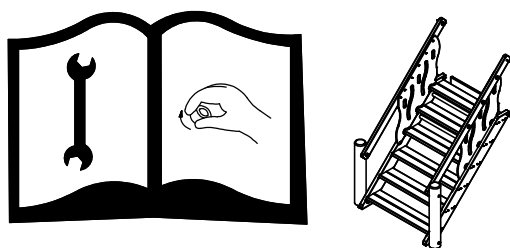

1x **S006A**

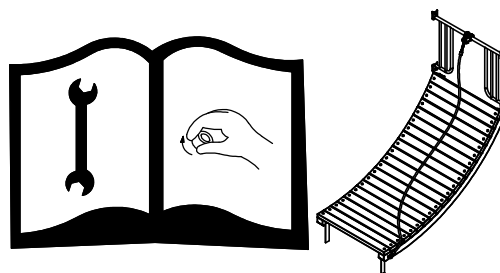

1x **S007A**

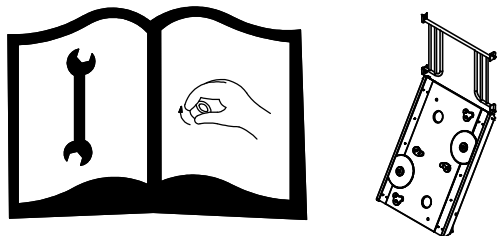

1x **S008A**

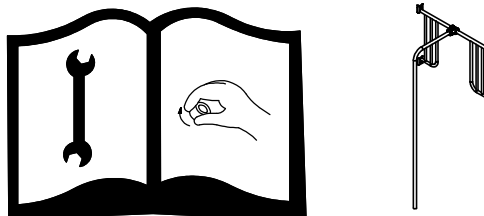

1x **S013A**

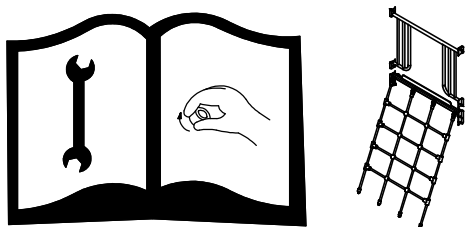

①

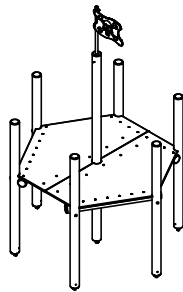
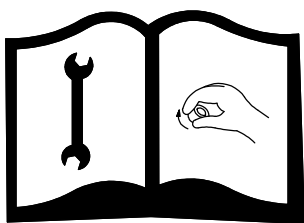
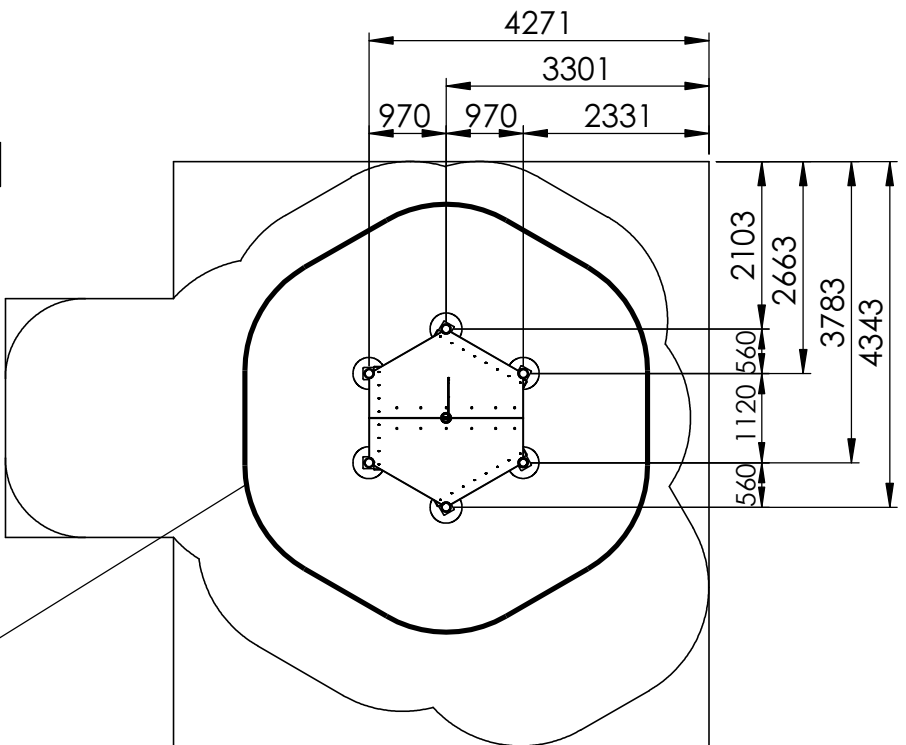
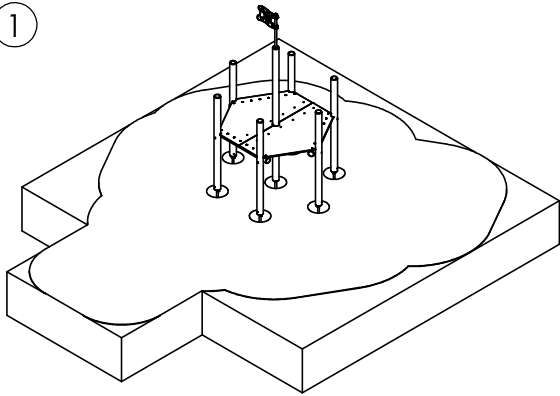

S440A

BASIC



②

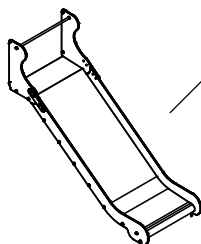
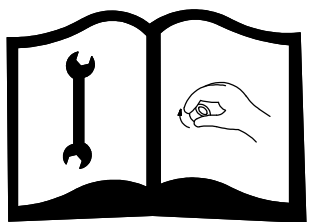
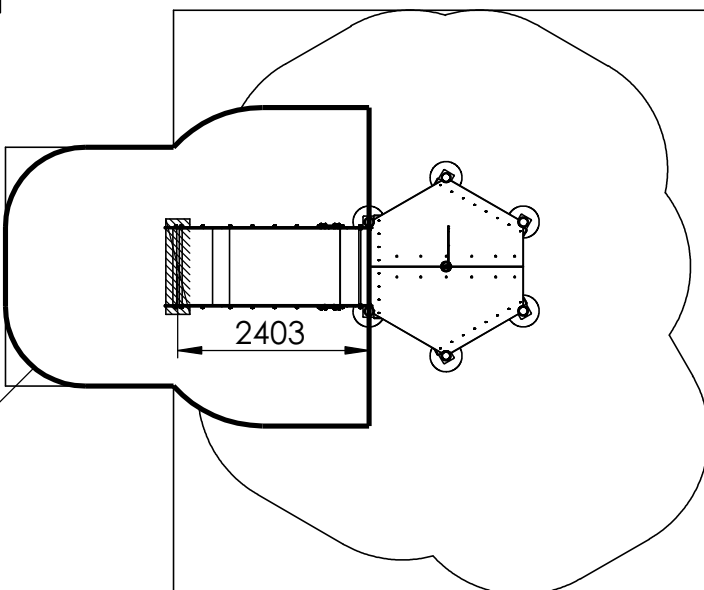
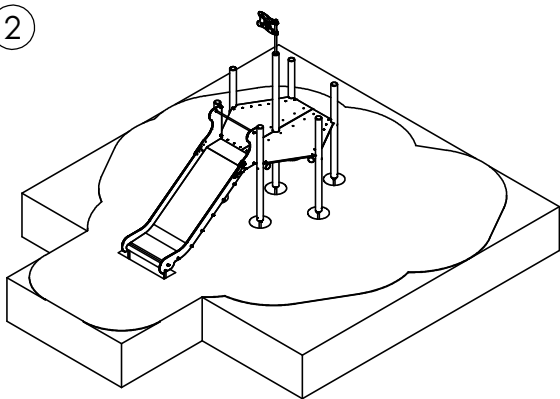

G112R/G A



3

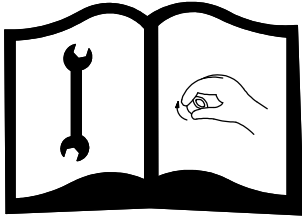
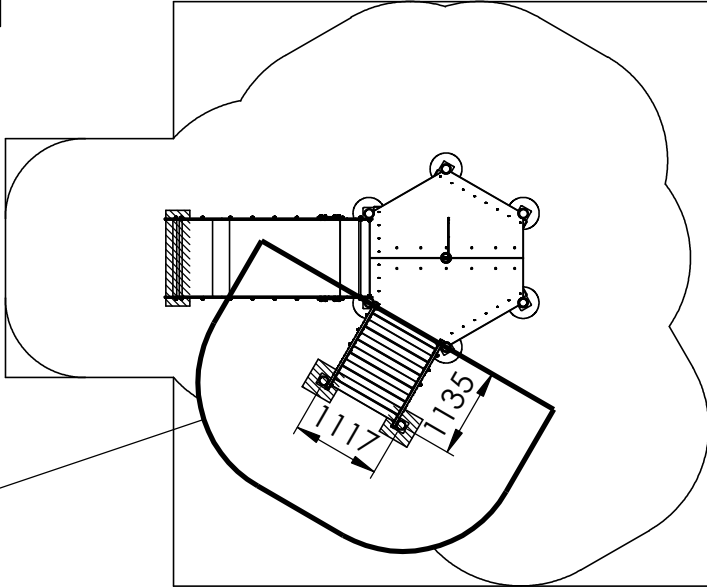
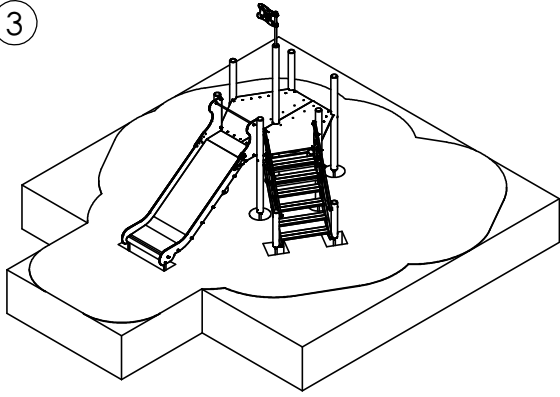

L710A

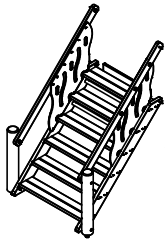

1 → 9 ~~10~~ → ~~11~~

4

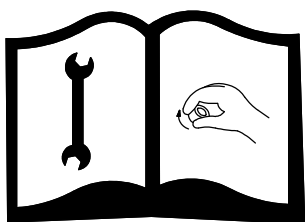
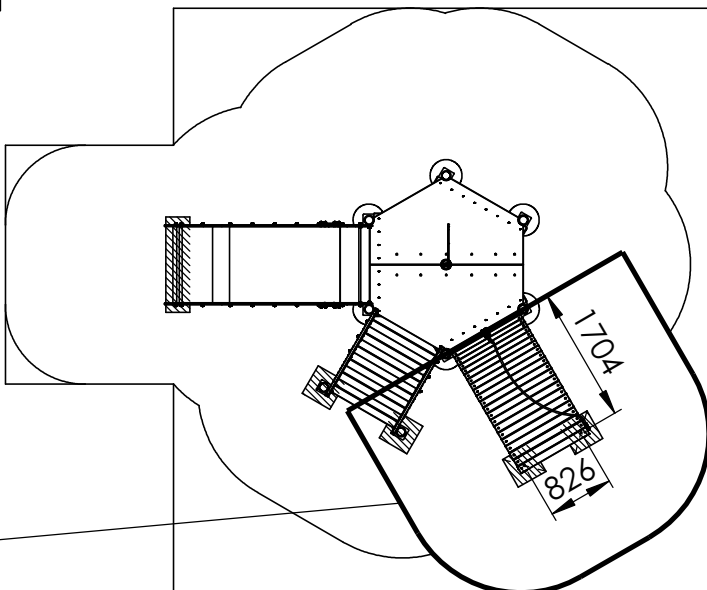
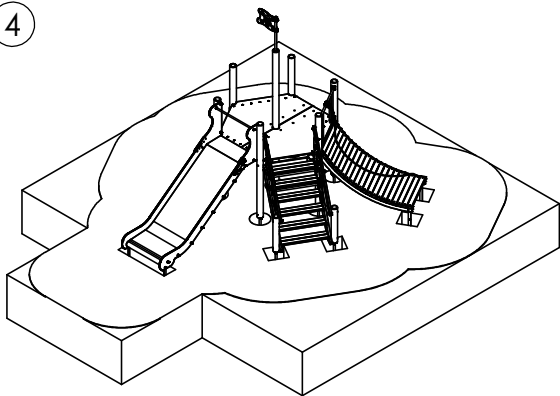

S006A

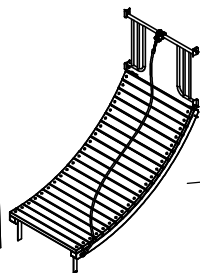

1 → 6 ~~7~~ → ~~8~~

5

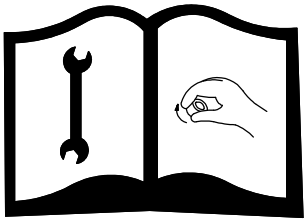
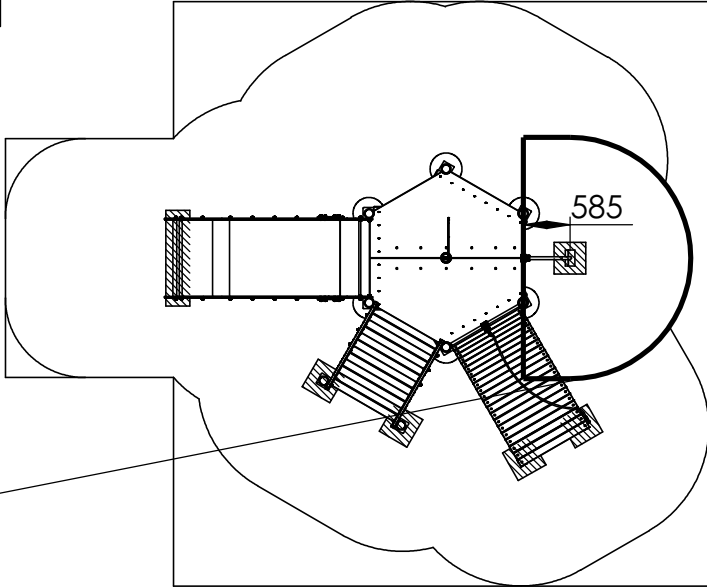
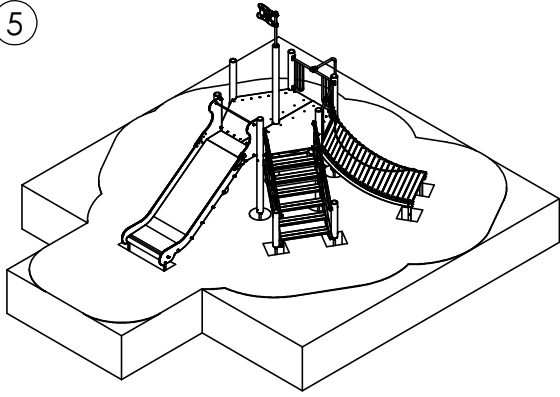

S008A

1 → 4 ~~5~~ → ~~6~~

6

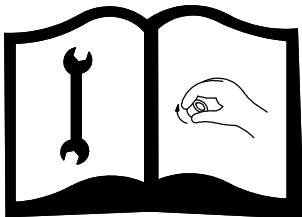
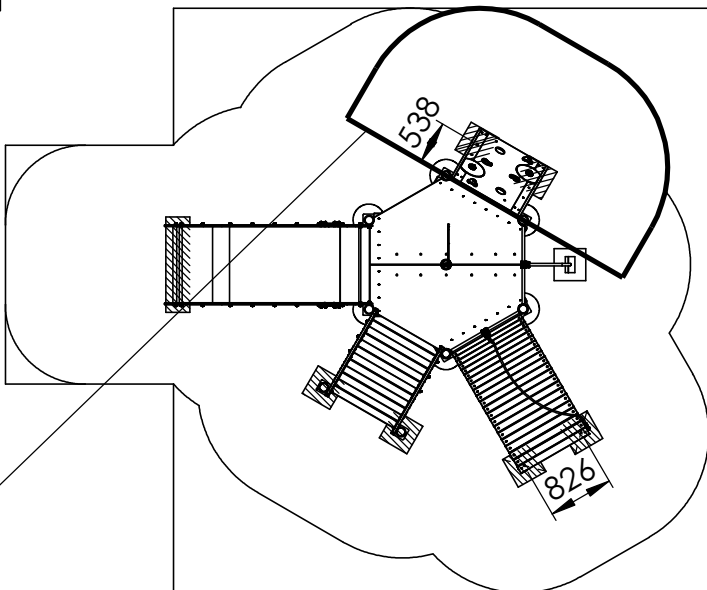
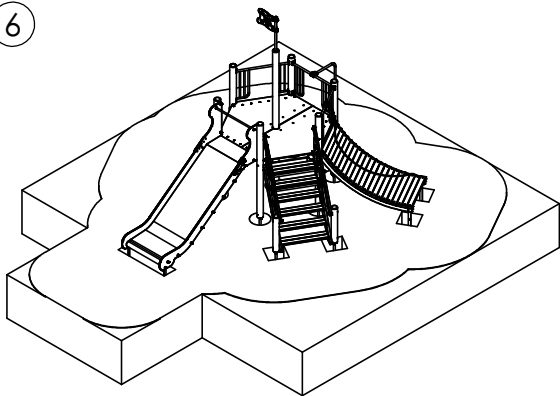

S007A

1 → 6 ~~7~~ → ~~8~~

7

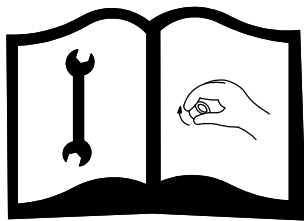
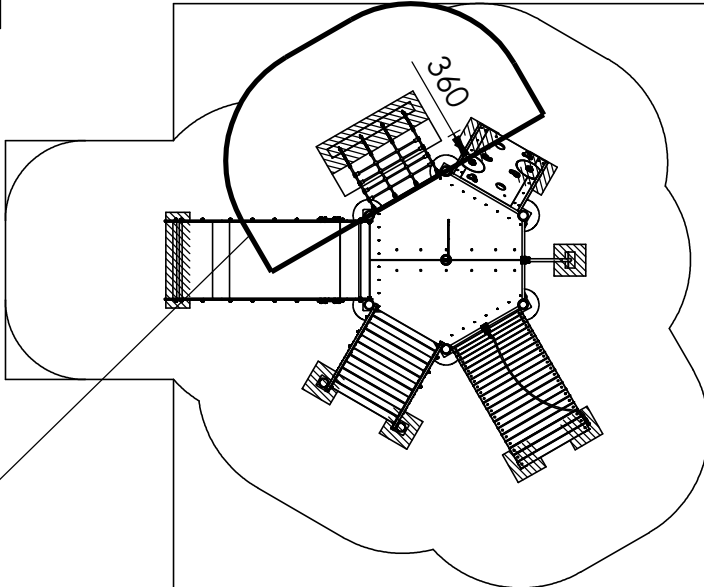
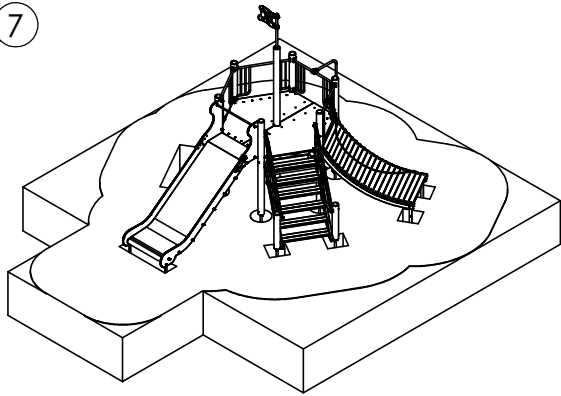

S013A

1 → 4 ~~5~~

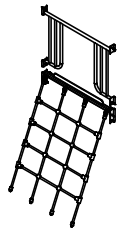

8

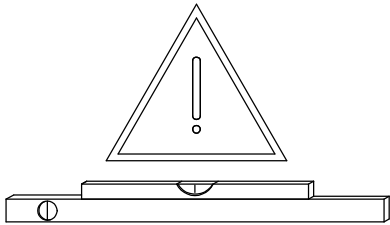

9

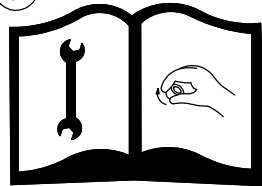

S440A BASIC

1 → ~~8~~ 9 → 10

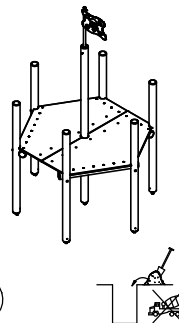

10

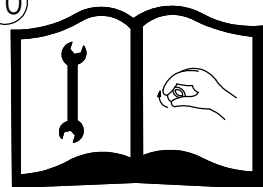

G112R/G A

1 → ~~3~~ 4 → 5

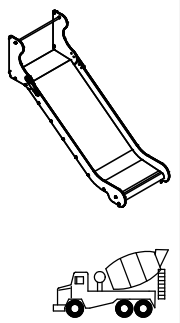

11

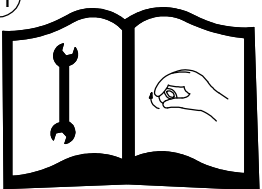

L710A

~~1~~ → 9 10 → 11

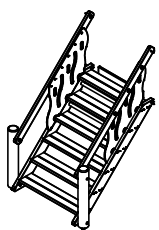

12

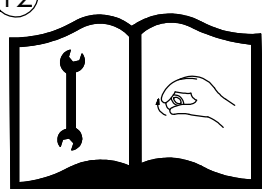

S006A

1 → ~~6~~ 7 → 8

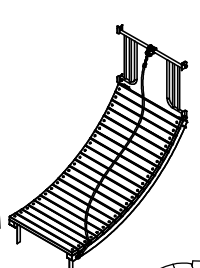

13

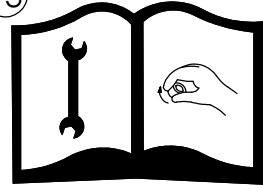

S008A

1 → ~~4~~ 5 → 6

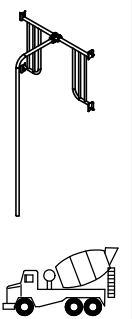

14

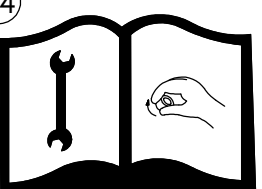

S007A

1 → ~~6~~ 7 → 8

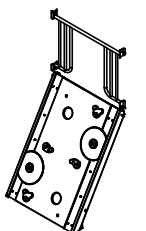

15

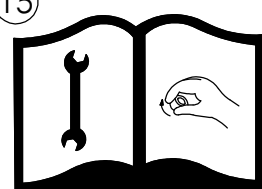

S013A

1 → ~~4~~ 5

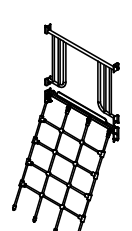

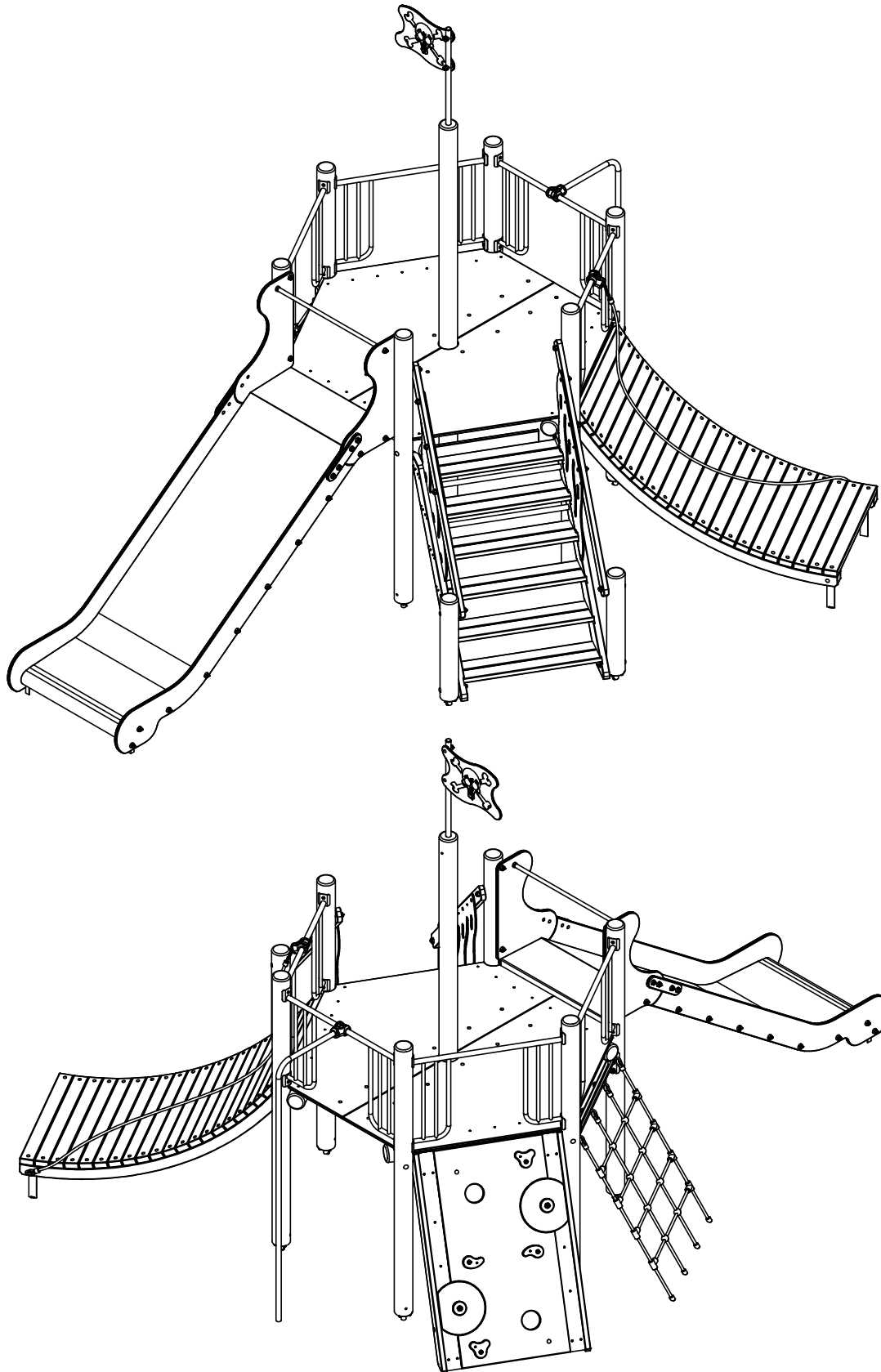

Bij droog weer moeten alle bouten en schroeven opnieuw aangespannen worden.
Par temps sec il faut resserrer régulièrement toute la visserie.

By dry and warm weather check the tightness of all bolts and screws.

①6 Bei trockenem Wetter müssen alle Schrauben und Bolzen aufs neue angespannt werden.

Para el tiempo seco, se necesita cerrar o ajustar los tornillos y tuercas.

Con tempo asciutto, tutti i bulloni e le viti devono essere avvitati nuovamente.