

MP250C

# OLIVIA

**Assembly instructions**  
 Montageanleitung • Montagevejledning

MiniPlay **LEDON**



58 cm

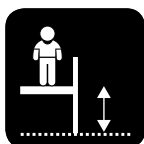

58 cm



0+



2



5H

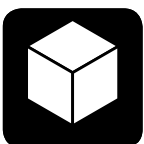

258,5 x 198 x 172 cm



558,5 x 448 cm

## Good advice and tips

Ein paar gute Ratschläge und Tipps • Gode råd og vejledning

### GB

- Take all components from the pallet and place them on the ground
- Compare with components list – is everything there?
- Be at all times precise when measuring
- Unpack one component at a time and assemble it
- Usage of a water-level will increase precision
- Fall protection is the very last thing to be installed – along with the producer's label

### D

- Alle Bauteile von der Palette nehmen und auf den Boden legen.
- Anhand der Bauteileliste überprüfen, ob alle Teile vorhanden sind
- Beim Abmessen generell präzise arbeiten
- Ein Bauteil nach dem anderen auspacken und montieren
- Die Benutzung einer Wasserwaage erleichtert die Montage
- Die Fallschutzunterlage wird erst ganz zum Schluss verlegt – dann, wenn das Produzentenetikett angebracht wird

### DK

- Tag komponenterne af pallen og læg dem på jorden
- Check efter komponentlisten om alle er med
- Vær omhyggelig med afstande generelt
- Pak én komponent ud af gangen og gør denne færdig
- Vær omhyggelig med brug af vatterpas
- Faldunderlag etableres til allersidst sammen med påsætning af mærkning med producent

# Clearance and safety surfaces

## Platzbedarf und Fallschutzunterlage • Pladshensyn og faldunderlag

Safety surface in accordance with EN 1176

Fallschutzunterlag gemäß EN 1176

Faldunderlag i overensstemmelse med EN 1176

	Height • Höhe • Højde	(*) Area • Fläche • Areal
<b>A</b>	60 cm	17,5 m <sup>2</sup>
<b>B</b>	(**)100 cm	2,86 m <sup>2</sup>
Total		20,36 m <sup>2</sup>

(\*) Areas are accurately calculated values which are difficult to achieve in practice.  
Die Flächen haben die genaue berechneten Werte, aber sind schwer in Praxis zu erreichen.  
Arealerne er nøjagtigt beregnede værdier, som er vanskelige at opnå i praksis.

(\*\*) Slide exit areas are equivalent to a height of 100 cm.  
Der Auslaufs Bereich der Rutsche, ist äquivalent eine Höhe von 100 cm.  
Rutsjebaneudløbsområder svarer til en højde på 100 cm.

Scale • Maßstab • Målstok 1:50

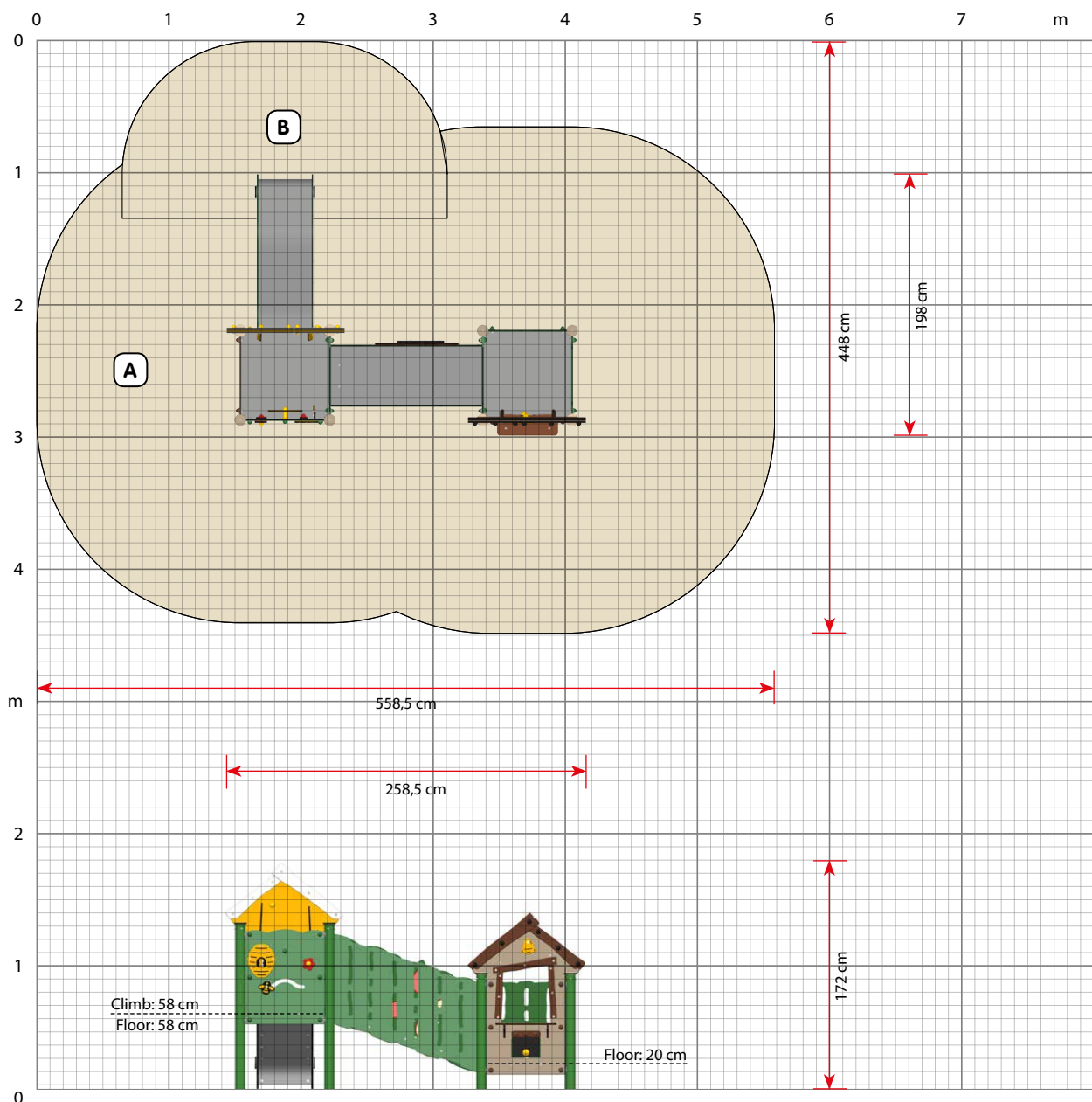

# Components overview

Bauteileübersicht • Komponentensicht

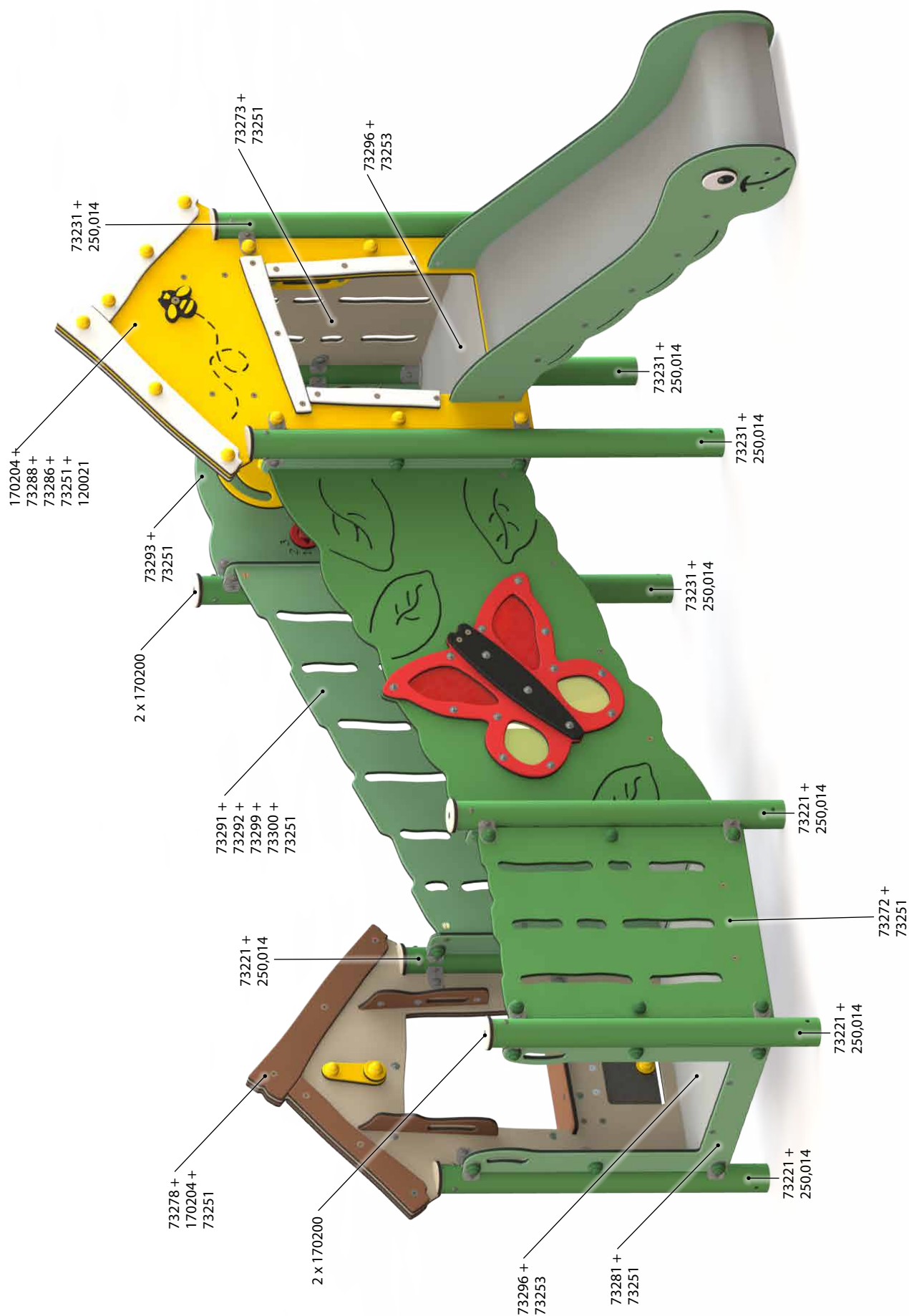

# Site preparation

Vorbereitung • Pladsforberedelse

⊕ Post positions • Pføstenpositionen • Stolpeplaceringer:

Scale 1:25

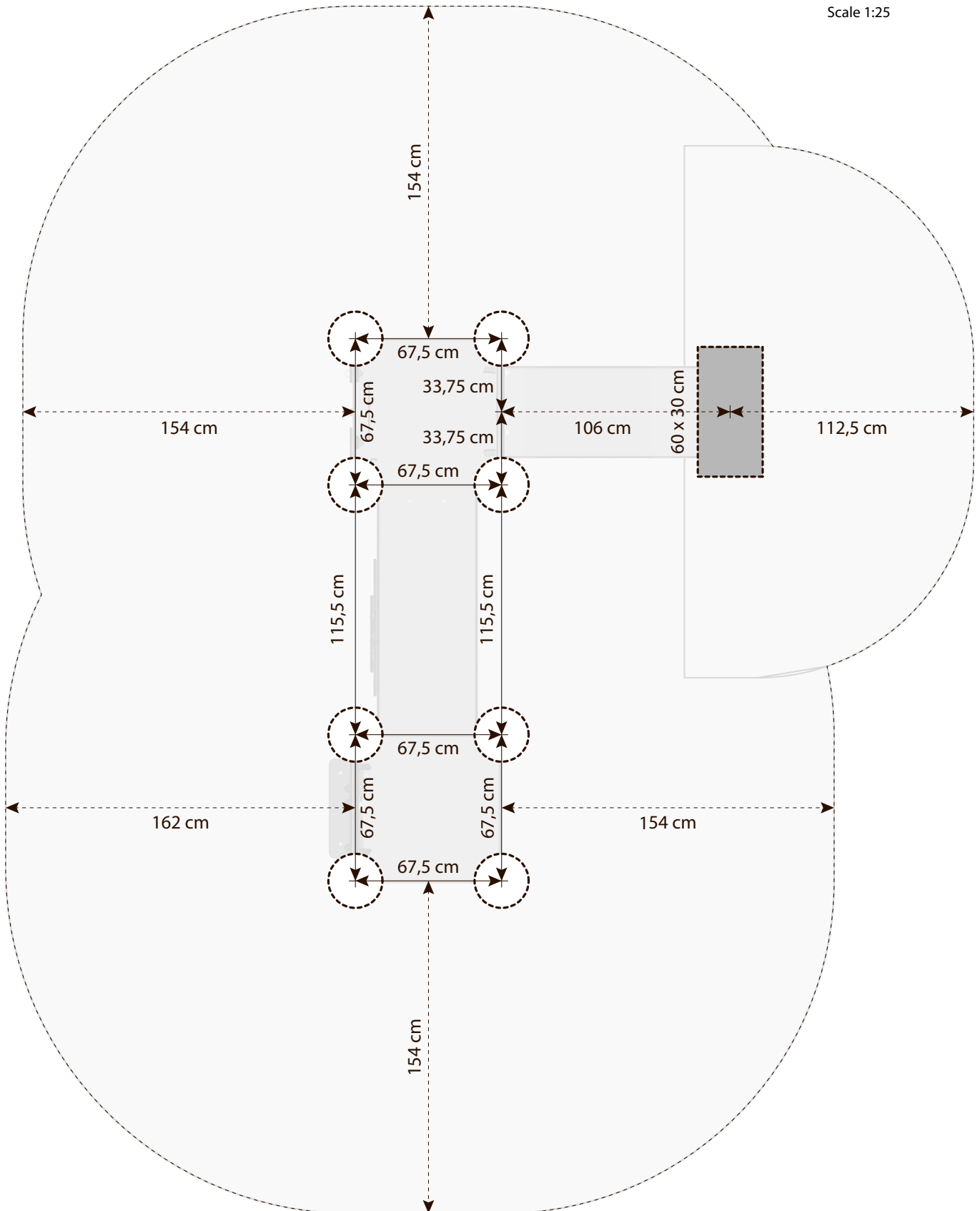

# Assembly

Montage • Montage

The numbers in the boxes refer to the relevant installation principles in separate compendium.  
 Die Zahlen in die Boxen referieren zu relevanten Montageprinzipien in separaten Kompendium.  
 Numrene i boksene henviser til relevante montageprincipper i separat kompendium.

#

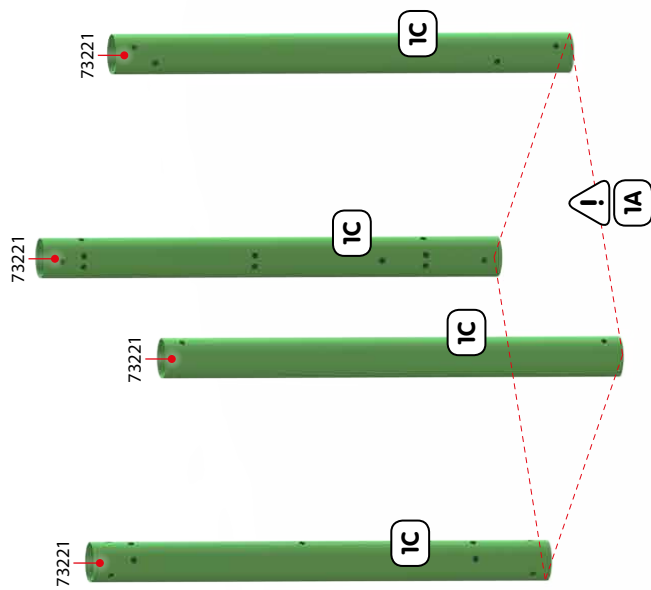
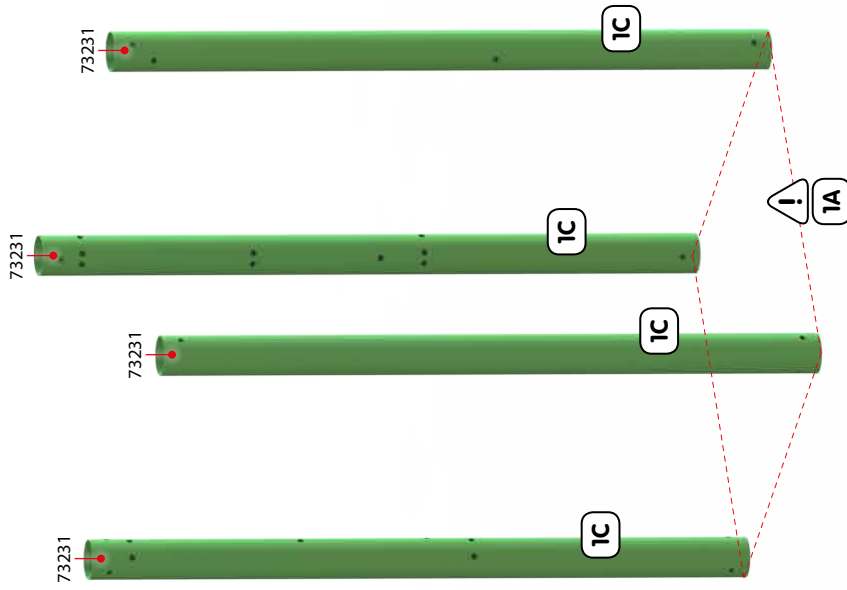

# Assembly

Montage • Montage



# Assembly

Montage • Montage

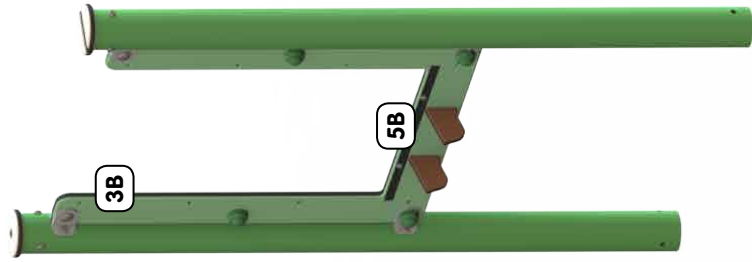
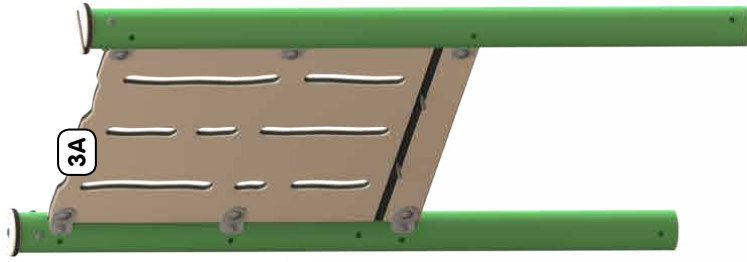



# Assembly

Montage • Montage

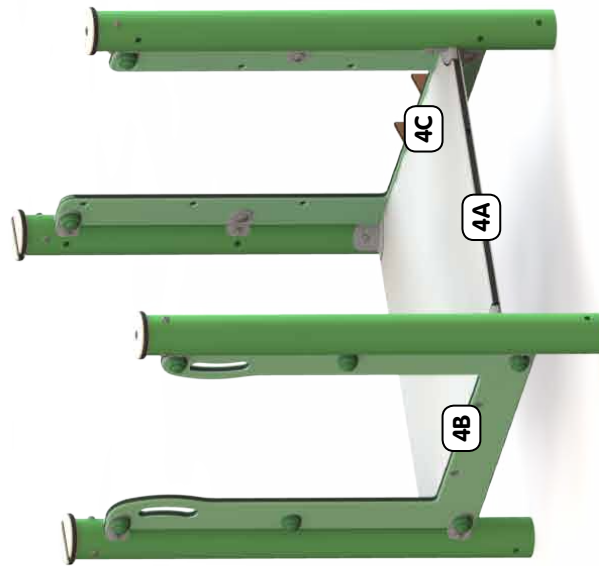
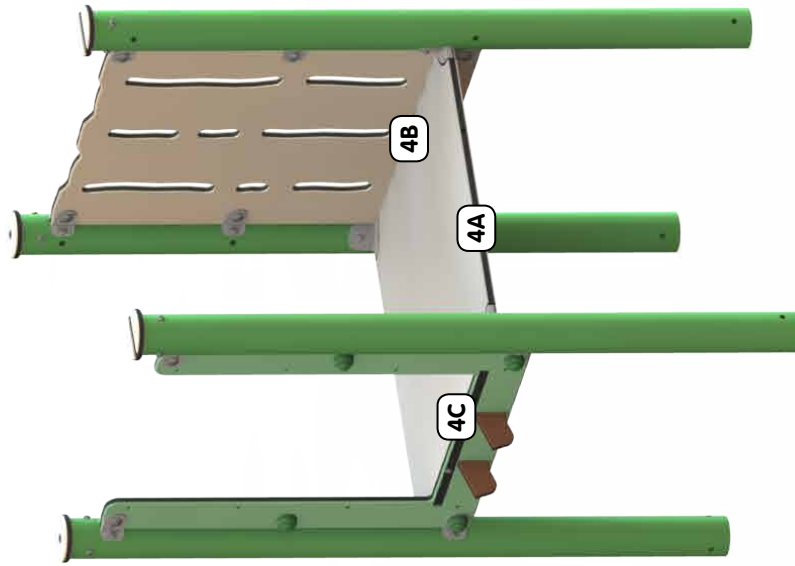

# Assembly

Montage • Montage

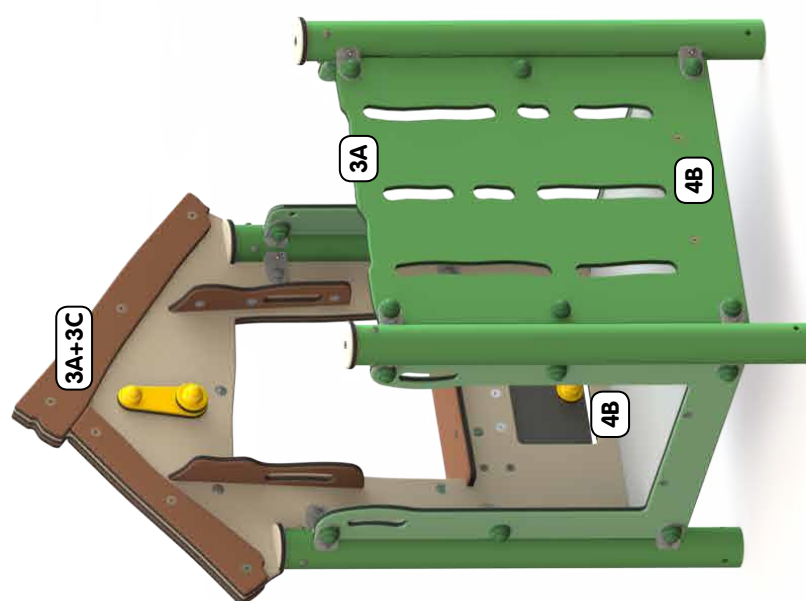
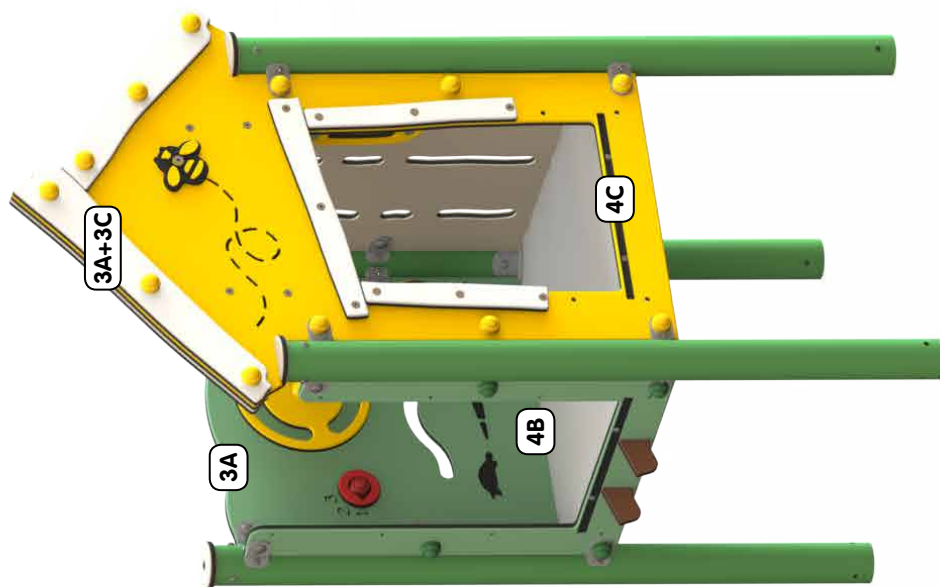

# Assembly

Montage • Montage



# Assembly

Montage • Montage



# Assembly

Montage • Montage



**Ready**  
Færdig • Færdig